

Model: D4DJ-300 X

Data

Type: Semi-hermetic piston compressors

Producer: Copeland

Series: DISCUS

Model: D4DJ-300 X

Technical data

Cylinder count:	4
Displacement [m ³ /h]:	84,7
Weight [kg]:	230
Oil charge [dm ³]:	4
Max. operating current [A]:	52
Locked rotor current [A]:	218
Power supply [V/~/Hz]:	380-420V/3/50Hz

Connections

	<u>milimeters</u>	<u>inches</u>
Suction line:		2 1/8"
Discharge line:		1 3/8"

Model: D4DJ-300 X

Capacity

R22

Cooling capacity [kW]

$t_c \setminus t_e$	-25	-20	-15	-10	-5	0	5	10
30	27.67	34.61	42.73	52.16	63.08	75.64	89.99	106.29
35	25.73	32.40	40.16	49.17	59.59	71.58	85.28	100.86
40	23.78	30.16	37.56	46.14	56.05	67.45	80.49	95.34
45	-	27.90	34.93	43.06	52.45	63.26	75.64	89.74
50	-	25.63	32.28	39.96	48.82	59.02	70.72	84.08
55	-	-	29.62	36.83	45.16	54.75	65.76	78.36
60	-	-	26.96	33.70	41.48	50.45	60.76	72.58

Power input [kW]

$t_c \setminus t_e$	-25	-20	-15	-10	-5	0	5	10
30	11.08	12.21	13.27	14.21	14.99	15.57	15.91	15.96
35	11.76	13.02	14.23	15.36	16.34	17.15	17.75	18.08
40	12.42	13.80	15.16	16.45	17.63	18.66	19.50	20.09
45	-	14.55	16.04	17.49	18.86	20.09	21.16	22.01
50	-	15.26	16.88	18.48	20.02	21.45	22.74	23.83
55	-	-	17.67	19.41	21.11	22.73	24.22	25.56
60	-	-	18.42	20.29	22.14	23.93	25.62	27.18

Model: D4DJ-300 X

Capacity

Current [A]

t_c \ t_e	-25	-20	-15	-10	-5	0	5	10
30	23.57	25.30	26.92	28.38	29.60	30.51	31.04	31.12
35	24.60	26.54	28.42	30.17	31.73	33.00	33.94	34.47
40	25.61	27.75	29.87	31.90	33.76	35.39	36.72	37.67
45	-	28.91	31.25	33.54	35.70	37.67	39.37	40.74
50	-	30.03	32.57	35.10	37.55	39.84	41.90	43.66
55	-	-	33.83	36.59	39.29	41.88	44.28	46.42
60	-	-	35.01	37.98	40.94	43.81	46.54	49.04

Mass flow [kg/s]

t_c \ t_e	-25	-20	-15	-10	-5	0	5	10
30	601.68	743.60	906.17	1 092.11	1 304.15	1 545.01	1 817.43	2 124.13
35	582.59	723.59	884.83	1 069.03	1 278.93	1 517.26	1 786.74	2 090.10
40	562.22	702.04	861.70	1 043.92	1 251.43	1 486.96	1 753.24	2 053.00
45	-	678.98	836.80	1 016.78	1 221.65	1 454.14	1 716.97	2 012.87
50	-	654.44	810.17	987.65	1 189.62	1 418.80	1 677.93	1 969.72
55	-	-	781.81	956.54	1 155.36	1 380.98	1 636.15	1 923.57
60	-	-	751.76	923.48	1 118.89	1 340.70	1 591.65	1 874.46

Model: D4DJ-300 X

Capacity

C.O.P. [W/W]

$t_c \setminus t_e$	-25	-20	-15	-10	-5	0	5	10
30	2.50	2.83	3.22	3.67	4.21	4.86	5.66	6.66
35	2.19	2.49	2.82	3.20	3.65	4.17	4.81	5.58
40	1.92	2.19	2.48	2.80	3.18	3.61	4.13	4.74
45	-	1.92	2.18	2.46	2.78	3.15	3.57	4.08
50	-	1.68	1.91	2.16	2.44	2.75	3.11	3.53
55	-	-	1.68	1.90	2.14	2.41	2.71	3.07
60	-	-	1.46	1.66	1.87	2.11	2.37	2.67

Application range

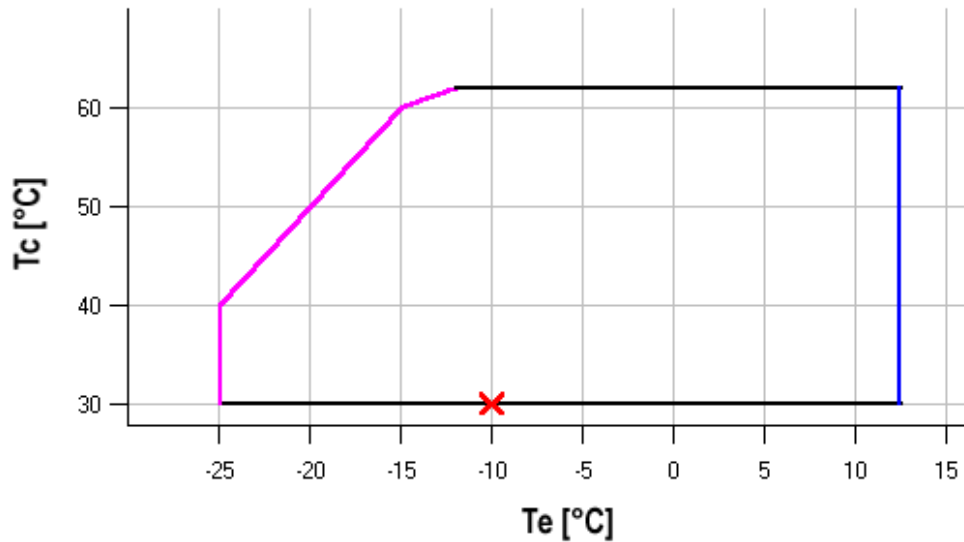

- █ Maximum evaporating temperature
- █ 25°C suction gas return

Operating conditions: ISO; subcooling: 0 K, suction superheat: 10 K, return gas temperature: -

t_c - Condensing temperature [°C]

t_e - Evaporating temperature [°C]

Model: D4DJ-300 X

Capacity

R134a

Cooling capacity [kW]

t_c \ t_e	-20	-15	-10	-5	0	5	10	15	20	25
40	16.77	21.88	27.96	35.19	43.76	53.82	65.57	79.16	-	-
45	15.14	20.02	25.80	32.65	40.75	50.27	61.39	74.28	89.12	106.08
50	13.54	18.18	23.64	30.10	37.72	46.69	57.17	69.35	83.40	99.49
55	11.96	16.36	21.49	27.54	34.68	43.09	52.93	64.39	77.63	92.84
60	-	14.56	19.36	25.00	31.65	39.48	48.67	59.40	71.83	86.15
65	-	12.80	17.26	22.47	28.61	35.86	44.39	54.38	65.99	-
70	-	-	15.18	19.96	25.59	32.25	40.11	49.35	60.13	-
75	-	-	-	17.48	22.59	28.65	35.83	44.30	54.25	-
80	-	-	-	15.03	19.61	25.06	31.55	39.25	-	-

Power input [kW]

t_c \ t_e	-20	-15	-10	-5	0	5	10	15	20	25
40	8.16	9.27	10.36	11.42	12.40	13.27	14.00	14.56	-	-
45	8.41	9.61	10.83	12.03	13.18	14.24	15.18	15.97	16.56	16.94
50	8.65	9.94	11.28	12.61	13.92	15.16	16.30	17.31	18.15	18.78
55	8.87	10.25	11.69	13.15	14.60	16.01	17.35	18.57	19.64	20.53
60	-	10.53	12.06	13.64	15.23	16.80	18.32	19.74	21.04	22.18
65	-	10.77	12.39	14.07	15.79	17.51	19.20	20.82	22.34	-
70	-	-	12.66	14.45	16.29	18.15	20.00	21.80	23.52	-
75	-	-	-	14.75	16.70	18.70	20.70	22.68	24.60	-
80	-	-	-	14.99	17.04	19.16	21.30	23.45	-	-

Model: D4DJ-300 X

Capacity

Current [A]

t_c \ t_e	-20	-15	-10	-5	0	5	10	15	20	25
40	18.87	20.09	21.38	22.69	23.94	25.08	26.05	26.78	-	-
45	19.15	20.50	21.96	23.47	24.98	26.40	27.69	28.78	29.62	30.13
50	19.41	20.89	22.51	24.22	25.96	27.66	29.26	30.70	31.92	32.85
55	19.67	21.25	23.03	24.92	26.88	28.84	30.74	32.52	34.11	35.45
60	-	21.58	23.49	25.57	27.74	29.95	32.13	34.23	36.19	37.93
65	-	21.87	23.91	26.14	28.51	30.96	33.42	35.84	38.14	-
70	-	-	24.26	26.65	29.21	31.88	34.61	37.32	39.96	-
75	-	-	-	27.07	29.81	32.70	35.67	38.68	41.65	-
80	-	-	-	27.40	30.31	33.40	36.61	39.90	-	-

Mass flow [kg/s]

t_c \ t_e	-20	-15	-10	-5	0	5	10	15	20	25
40	437.65	560.13	700.75	862.56	1 048.59	1 261.89	1 505.48	1 782.40	-	-
45	419.17	541.71	682.05	843.20	1 028.21	1 240.12	1 481.95	1 756.75	2 067.55	2 417.39
50	399.67	522.06	661.87	822.13	1 005.88	1 216.16	1 456.00	1 728.44	2 036.52	2 383.27
55	379.35	501.35	640.39	799.52	981.78	1 190.20	1 427.82	1 697.67	2 002.79	2 346.21
60	-	479.76	617.81	775.58	956.11	1 162.43	1 397.58	1 664.60	1 966.53	2 306.39
65	-	457.48	594.30	750.47	929.03	1 133.02	1 365.48	1 629.44	1 927.93	-
70	-	-	570.05	724.39	900.75	1 102.17	1 331.70	1 592.35	1 887.18	-
75	-	-	-	697.51	871.44	1 070.06	1 296.41	1 553.54	1 844.46	-
80	-	-	-	670.03	841.28	1 036.87	1 259.82	1 513.17	-	-

Model: D4DJ-300 X

Capacity

C.O.P. [W/W]

$t_c \setminus t_e$	-20	-15	-10	-5	0	5	10	15	20	25
40	2.05	2.36	2.70	3.08	3.53	4.06	4.68	5.44	-	-
45	1.80	2.08	2.38	2.71	3.09	3.53	4.04	4.65	5.38	6.26
50	1.57	1.83	2.10	2.39	2.71	3.08	3.51	4.01	4.60	5.30
55	1.35	1.60	1.84	2.09	2.37	2.69	3.05	3.47	3.95	4.52
60	-	1.38	1.61	1.83	2.08	2.35	2.66	3.01	3.41	3.88
65	-	1.19	1.39	1.60	1.81	2.05	2.31	2.61	2.95	-
70	-	-	1.20	1.38	1.57	1.78	2.01	2.26	2.56	-
75	-	-	-	1.18	1.35	1.53	1.73	1.95	2.21	-
80	-	-	-	1.00	1.15	1.31	1.48	1.67	-	-

Application range

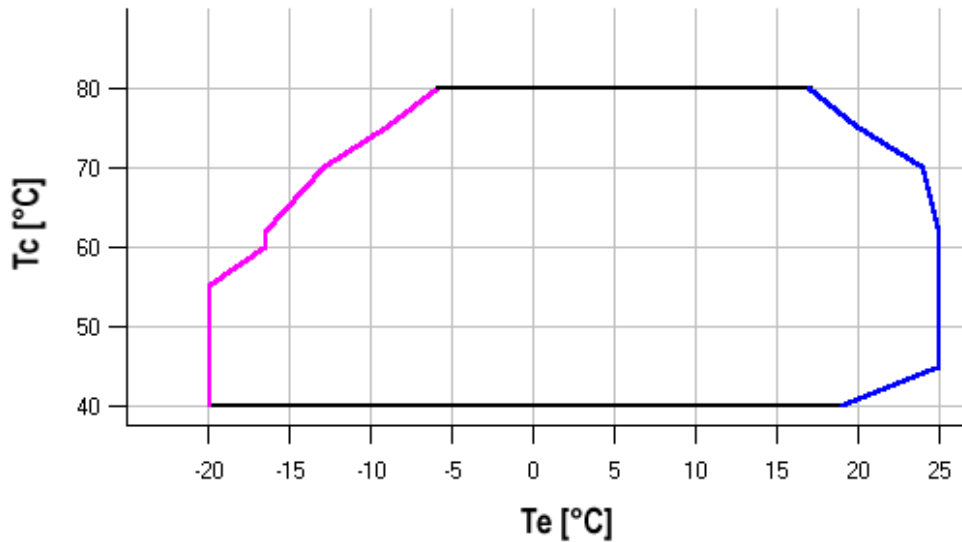

 Maximum evaporating temperature

 20K suction superheat

Operating conditions: ISO; subcooling: 0 K, suction superheat: 10 K, return gas temperature: -

t_c - Condensing temperature [°C]

t_e - Evaporating temperature [°C]

Model: D4DJ-300 X

Capacity

R404A/R507

Cooling capacity [kW]

$t_c \setminus t_e$	-35	-30	-25	-20	-15	-10	-5	0	5
20	22.25	28.58	36.15	45.13	55.68	67.97	82.16	98.41	116.89
25	20.37	26.41	33.58	42.05	51.98	63.52	76.86	92.14	109.54
30	18.48	24.23	31.00	38.95	48.24	59.05	71.52	85.84	102.15
35	16.59	22.04	28.40	35.83	44.49	54.55	66.17	79.51	94.73
40	-	19.85	25.80	32.70	40.73	50.03	60.79	73.15	87.29
45	-	17.65	23.19	29.57	36.95	45.51	55.39	66.78	79.83
50	-	15.46	20.58	26.43	33.17	40.97	49.99	60.39	72.35
55	-	13.28	17.98	23.30	29.40	36.44	44.58	54.00	64.86

Power input [kW]

$t_c \setminus t_e$	-35	-30	-25	-20	-15	-10	-5	0	5
20	9.63	10.72	11.72	12.63	13.44	14.15	14.75	15.23	15.59
25	9.99	11.24	12.41	13.49	14.48	15.38	16.16	16.83	17.38
30	10.26	11.68	13.03	14.30	15.48	16.56	17.54	18.41	19.17
35	10.42	12.03	13.57	15.02	16.40	17.68	18.87	19.95	20.92
40	-	12.27	14.01	15.67	17.25	18.74	20.14	21.44	22.64
45	-	12.40	14.34	16.21	18.01	19.73	21.35	22.88	24.31
50	-	12.40	14.56	16.65	18.68	20.62	22.48	24.25	25.92
55	-	12.26	14.65	16.98	19.24	21.42	23.53	25.54	27.46

Model: D4DJ-300 X

Capacity

Current [A]

$t_c \setminus t_e$	-35	-30	-25	-20	-15	-10	-5	0	5
20	21.05	22.24	23.31	24.20	24.88	25.31	25.44	25.23	24.64
25	21.41	22.94	24.37	25.65	26.74	27.60	28.19	28.46	28.38
30	21.62	23.46	25.23	26.87	28.36	29.63	30.66	31.40	31.80
35	21.70	23.84	25.92	27.91	29.76	31.43	32.88	34.06	34.93
40	-	24.08	26.46	28.78	30.98	33.02	34.86	36.47	37.78
45	-	24.22	26.89	29.50	32.03	34.43	36.65	38.65	40.40
50	-	24.29	27.21	30.11	32.95	35.67	38.25	40.64	42.79
55	-	24.30	27.46	30.62	33.75	36.79	39.70	42.45	44.98

Mass flow [kg/s]

$t_c \setminus t_e$	-35	-30	-25	-20	-15	-10	-5	0	5
20	482.63	632.32	805.05	1 008.04	1 248.49	1 533.62	1 870.64	2 266.75	2 729.16
25	465.71	613.56	784.13	984.63	1 222.28	1 504.28	1 837.84	2 230.17	2 688.48
30	446.16	592.31	760.85	959.00	1 193.98	1 472.98	1 803.21	2 191.90	2 646.25
35	424.27	568.84	735.49	931.43	1 163.86	1 440.00	1 767.05	2 152.23	2 602.74
40	-	543.45	708.34	902.19	1 132.21	1 405.62	1 729.62	2 111.42	2 558.23
45	-	516.40	679.66	871.56	1 099.31	1 370.12	1 691.20	2 069.75	2 513.00
50	-	487.97	649.74	839.83	1 065.44	1 333.78	1 652.07	2 027.51	2 467.32
55	-	458.45	618.86	807.26	1 030.86	1 296.87	1 612.51	1 984.98	2 421.49

Model: D4DJ-300 X



Capacity

C.O.P. [W/W]

$t_c \setminus t_e$	-35	-30	-25	-20	-15	-10	-5	0	5
20	2.31	2.67	3.09	3.57	4.14	4.80	5.57	6.46	7.50
25	2.04	2.35	2.71	3.12	3.59	4.13	4.76	5.47	6.30
30	1.80	2.07	2.38	2.72	3.12	3.57	4.08	4.66	5.33
35	1.59	1.83	2.09	2.38	2.71	3.08	3.51	3.99	4.53
40	-	1.62	1.84	2.09	2.36	2.67	3.02	3.41	3.86
45	-	1.42	1.62	1.82	2.05	2.31	2.59	2.92	3.28
50	-	1.25	1.41	1.59	1.78	1.99	2.22	2.49	2.79
55	-	1.08	1.23	1.37	1.53	1.70	1.90	2.11	2.36

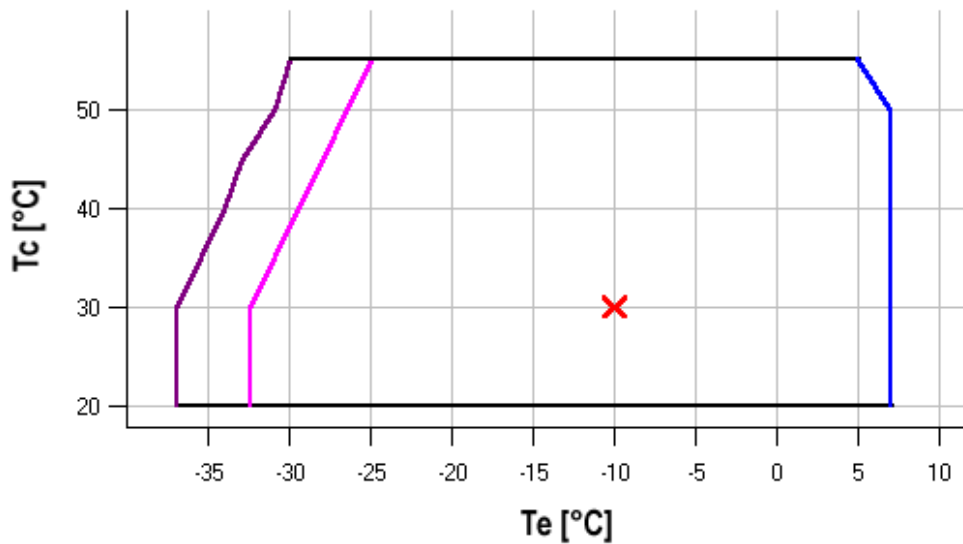
Application range



-  Maximum evaporating temperature
-  25°C suction gas return
-  25°C suction gas return + additional cooling

Operating conditions: ISO; subcooling: 0 K, suction superheat: - K, return gas temperature: 20

t_c - Condensing temperature [°C]

t_e - Evaporating temperature [°C]

Model: D4DJ-300 X

Capacity

R407C

Cooling capacity [kW]

t_c \ t_e	-20	-15	-10	-5	0	5	10	15
35	27.34	34.61	43.41	53.85	66.06	80.14	96.24	-
40	25.10	31.83	40.02	49.77	61.21	74.46	89.63	-
45	22.97	29.18	36.77	45.84	56.53	68.94	83.21	-
50	-	26.65	33.64	42.05	51.99	63.58	76.95	-
55	-	24.22	30.64	38.39	47.59	58.38	70.86	-
60	-	-	27.75	34.85	43.34	53.32	64.92	-

Power input [kW]

t_c \ t_e	-20	-15	-10	-5	0	5	10	15
35	11.82	13.11	14.37	15.52	16.52	17.29	17.78	-
40	12.83	14.23	15.63	16.96	18.17	19.19	19.96	-
45	13.80	15.29	16.81	18.31	19.71	20.96	21.99	-
50	-	16.29	17.92	19.55	21.13	22.59	23.87	-
55	-	17.25	18.96	20.72	22.45	24.10	25.60	-
60	-	-	19.94	21.80	23.67	25.49	27.20	-

Model: D4DJ-300 X

Capacity

Current [A]

$t_c \setminus t_e$	-20	-15	-10	-5	0	5	10	15
35	25.23	26.98	28.74	30.39	31.85	32.99	33.72	-
40	26.60	28.54	30.54	32.49	34.30	35.85	37.04	-
45	27.95	30.05	32.27	34.50	36.64	38.57	40.20	-
50	-	31.51	33.93	36.41	38.85	41.15	43.19	-
55	-	32.92	35.51	38.22	40.94	43.57	46.01	-
60	-	-	37.00	39.91	42.89	45.83	48.63	-

Mass flow [kg/s]

$t_c \setminus t_e$	-20	-15	-10	-5	0	5	10	15
35	603.39	751.16	926.35	1 130.48	1 365.05	1 631.59	1 931.60	-
40	583.67	726.70	897.23	1 096.78	1 326.85	1 588.97	1 884.66	-
45	564.86	703.29	869.30	1 064.41	1 290.13	1 547.98	1 839.47	-
50	-	681.34	842.98	1 033.79	1 255.29	1 509.01	1 796.45	-
55	-	661.27	818.67	1 005.33	1 222.77	1 472.50	1 756.03	-
60	-	-	796.81	979.46	1 192.97	1 438.85	1 718.62	-

Model: D4DJ-300 X



Capacity

C.O.P. [W/W]

$t_c \setminus t_e$	-20	-15	-10	-5	0	5	10	15
35	2.31	2.64	3.02	3.47	4.00	4.63	5.41	-
40	1.96	2.24	2.56	2.93	3.37	3.88	4.49	-
45	1.66	1.91	2.19	2.50	2.87	3.29	3.78	-
50	-	1.64	1.88	2.15	2.46	2.81	3.22	-
55	-	1.40	1.62	1.85	2.12	2.42	2.77	-
60	-	-	1.39	1.60	1.83	2.09	2.39	-

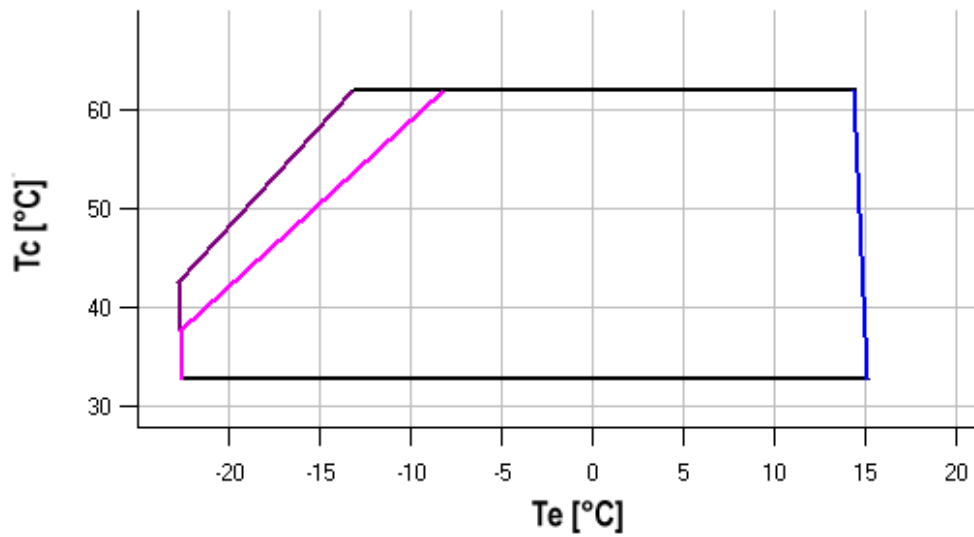
Application range



-  Maximum evaporating temperature
-  25°C suction gas return
-  20K suction superheat

Operating conditions: ISO; subcooling: 0 K, suction superheat: 10 K, return gas temperature: -

t_c - Condensing temperature [°C]

t_e - Evaporating temperature [°C]

Model: D4DJ-300 X
Dimensions

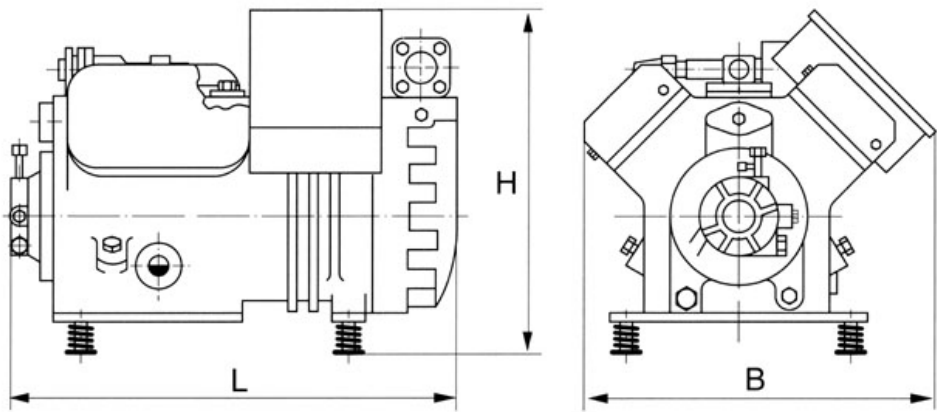

L	690 mm
B	535 mm
H	495 mm

Model: D4DJ-300 X

Image

